

QUICKSILVER®

ACTIV

SUNDECK CRUISER



20
17

THE QUICKSILVER ACTIV RANGE HAS ALWAYS PERFECTLY BLENDED FUN AND STYLE WITH PRACTICALITY AND SAFETY.

The evolving direction of the Quicksilver Activ range now builds on this strength with collaborations between highly experienced designers, engineers and naval architects from the Brunswick Group, a leading force in the boating world. A strong partnership that has led to an even greater line-up of fun boats with true integrity and depth.

Quicksilver Activ promises a world of style and innovative use of space made possible by the best in class length to beam ratio which also increases stability. A confidence further heightened by the deep V hull design creating a form that cuts through water efficiently and comfortably. A direct result of one of the most experienced naval architects in the industry being part of the team behind Quicksilver Activ.

So as you can see, we take fun very seriously. Welcome to style and substance.

Explore our complete range of boats and dealer network now at www.quicksilver-boats.com





CONTENT

Introduction _____	4
The Smart Edition _____	5
ACTIV 805 CRUISER _____	6
NEW ACTIV 755 CRUISER _____	10
ACTIV 645 CRUISER _____	14
ACTIV 595 CRUISER _____	18
ACTIV 805 SUNDECK _____	22
ACTIV 755 SUNDECK _____	26
NEW ACTIV 675 SUNDECK _____	30
NEW ACTIV 605 SUNDECK _____	34
Specifications & Packs _____	38

Life is now

WELCOME TO THE CRUISER & SUNDECK RANGE FROM QUICKSILVER.

The moment you look at an Activ, you know that it's designed for pure fun.

It's about fluid yet solid forms with soft lines and sharp, cut-through shapes creating a dynamic, sporty tension that says it's playtime. Purposeful designs still true to the essence and character of the original sketches; that spontaneous spark of inspiration. Creativity founded on experience, considered development and insight gained through solid research into the needs and desires of boat users resulting in a range of boats that offers you true freedom with the reassurance of structural and engineering integrity. Everything underpinned by safety, comfort and versatility.

So you can cruise, water ski, or just soak up the sun with complete peace of mind.

And with ease.

This is Activ.
Built on understanding.
Shaped by you.
Created for escape.

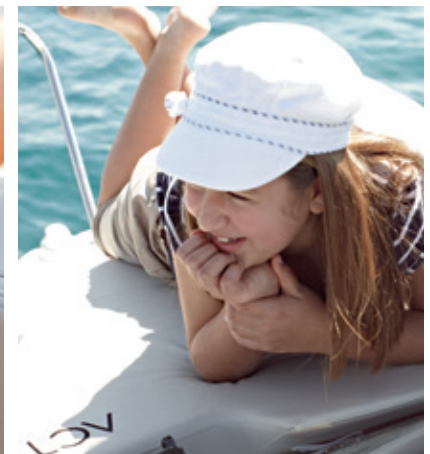
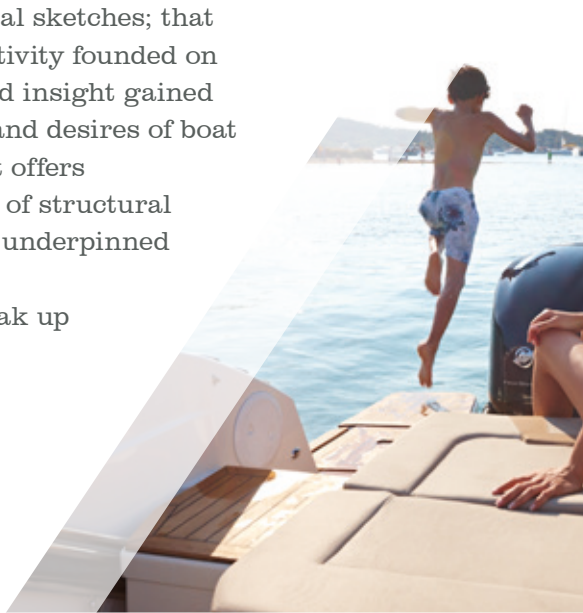



SMART EDITION
THE BEST WAY TO GET
THE OPTIONS YOU NEED

People are different. So why should every boat be the same?

We have designed our boats for optimal use,
but we know that everybody has their own preferences.
That's why we are introducing the Smart Edition.

The Smart Edition gives you what you need: a variety of option sets
that are most frequently requested by our customers.
So you can be sure you get the options you want.

Best of all, the Smart Edition has short delivery times and is
probably already available at your local dealer right now –
you'll be on the water before you know it.

ACTIV 805 CRUISER

LUXURY PERFORMANCE DAY-CRUISER

Designed with attention to detail, the Activ 805 Cruiser is our flagship model for day cruising. Refinement, power, safety and comfort are the key values you'll appreciate in this smart new addition to our line-up. Powered by up to 400hp of engine power and accommodating up to nine for day cruising and refined sport and leisure use with family and friends, the Activ 805 Cruiser is the ultimate in smooth and stylish performance on the water.



Length Overall (M)	7,88
Beam Maximum (M)	2,55
Height - Without Canvas (M)	2,26
Dry Weight (Kg)	1813
Fuel Capacity (L)	280
CE Design Category	C
Maximum Number of People	9
Maximum Power (HP/kW)	400 / 294

ACTIV 805 CRUISER



SAFETY

The Activ 805 offers a wide range of safety features that will allow you to enjoy the water in complete security. With a hull designed for safe yet high-performance use and a high level of navigation console accessibility and visibility, it's an extremely safe craft at any speed and in a variety of weather conditions. The easy stern access and twin swim platforms include a robust ladder allowing for equally easy access directly from the water.

DESIGN

With its sleek, fluid lines, the Activ 805 Cruiser's perfect proportions create a powerful presence on the water. The high-spec exterior fittings and intelligent design elements give the boat a unique style, complemented by high-end finishing such as LED courtesy lights and teak cockpit table. The interiors are fitted out in elegance and style, with eye for detail in the upholstery finishing, cabinets and wooden trim giving an overall sense of refinement.

COMFORT

With overnight accommodation facilities designed to cater for up to four adults, the Activ 805 Cruiser offers a spacious and airy double forward cabin, twin mid-berths, a practical yet private marine toilet with its own window and sink and a robust and practical galley with a refrigerator, fresh water system and stove. For daytime use the Activ 805 Cruiser accommodates up to nine adults in comfort and style.

VERSATILITY

The last word in versatility, the Activ 805 Cruiser offers multiple configurations for fun and leisure use with family and friends, whether it's for skiing, water sports or coastal cruising. Three different cockpit configurations from comfortable cockpit seating to dining area and to spacious sun lounge. The cockpit teak dining table seats five people. Not to mention an optional full size foredeck sun lounge.

SMART EDITION

Be sure to get what you need: the Smart Edition is based on the options that are most frequently requested by our customers. In addition to that you save an average of 10% when compared to ordering options separately.



ACTIV 805 CRUISER



1 Versatile cockpit area, convertible to completely extended sun lounge area for maximum sunbathing capacity and easy water access



1 Versatile cockpit area, convertible to sun lounge area with inclined backrest, ideal for reading and relaxing



1 Versatile cockpit area, convertible to dining area



2 Permanent galley with stainless steel sink with cutting board lid, standard 12V cooler, optional fridge & LPG stove



12 Enclosed canvas storage

Comfortable bucket seat
Double co-pilot seat with storage below seat



16 & 17

7-8 & 10



Main forward berth with large skylights and deck hatch

10



Separated head with sink & optional sea toilet

10



Mid berth with 2 single or one double berth

5



Easy walking access from bow to stern

MODEL FEATURES

1. Versatile cockpit area, convertible for: 1) cruising and dining area 2) sun lounge area with inclined backrest, ideal for reading and relaxing 3) completely extended sun lounge area for maximum sunbathing capacity and easy water access
2. Permanent galley with stainless steel sink with cutting board lid, standard 12V cooler, optional fridge & LPG stove
3. Ergonomic helm with instrumentation, optional 9" Simrad Chart Plotter, Mercury NMEA 2000 gateway module for engine data and SmartCraft instrumentation
4. Storage area for small items and beverages in front of pilot and co pilot seats
5. Easy walking access from bow to stern
6. Wide steps to access the foredeck
7. Large skylights on deck and the side of the hull for ample light in cabin
8. Cabin hatch provides ventilation
9. Anchor storage/windlass
10. Cabin for 4 adults consisting of main forward berth, mid berth, separated sink and optional toilet
11. Wide aft cockpit entry
12. Enclosed canvas storage
13. Double swim platform
14. Motor well bridge: easy access to both sides of transom
15. Single or twin engine configuration capability of max 400 hp
16. Comfortable bucket seat
17. Double co-pilot seat with storage below seat

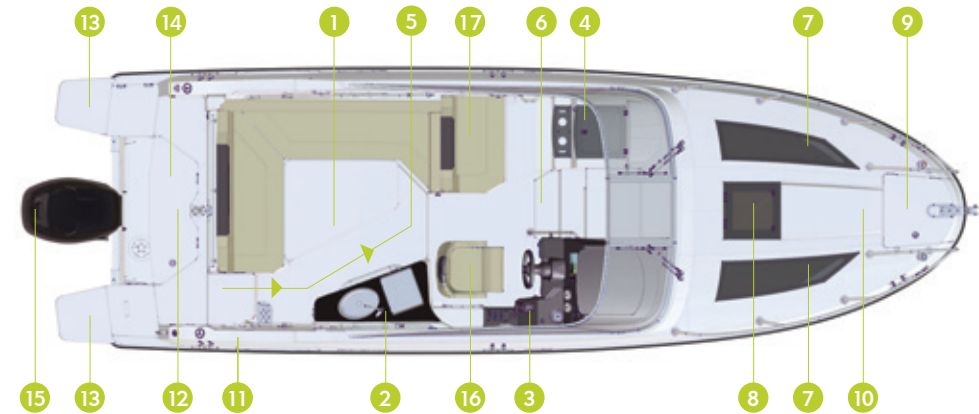

ACTIV 755 CRUISER

ENJOY THE VIEW

Break away for a day trip or a weekend on the water. The Activ 755 Cruiser's deep cockpit and full windscreen keep you and your passengers safe and dry during the ride. Inside, the cabin's wide windows offer the best views you'll ever find in a 7-meter boat.

Customisation is key. The cockpit area offers 3 configurations, several packs allow for significant upgrades of the boat's accessories and there's a whole range of Mercury engines available.



Length Overall (M)	6,99
Beam Maximum (M)	2,55
Height - Without Canvas (M)	2,03
Dry Weight (Kg)	1440
Fuel Capacity (L)	280
CE Design Category	C
Maximum Number of People	8
Maximum Power (HP/KW)	300 / 221



SAFETY

The Activ 755 Cruiser is powered by a single outboard Mercury engine with up to 300 hp, ensuring secure and agile navigation. Accessibility features include a wide cockpit entry, smartly positioned handrails all around, easy walking access from bow to stern and swim platforms to slide into the water. With its deep cockpit, the boat is also suitable to take children along for a safe ride. A full windscreen with windscreen wiper adds to the weather protection.

DESIGN

Its distinctive external lines give the boat an uncluttered, smooth and sporty look. Eye catchers are the bicolour helm, the sleek windshield and the new electric blue hull colour. Smart design created room for integrated armrests with cup holders, a cockpit galley for outside cooking and invisible canvas storage. The cabin makes the most of the available space and light with a roomy berth, large windows and integrated storages.

COMFORT

Passengers are well taken care of wherever they are on the Activ 755 Cruiser. The large cockpit lets you enjoy being outside and on the water as much as possible. It includes a fully galley with sink, LPG stove and refrigerator. Large swim platforms provide easy access to the water and wide steps do the same for cabin entry.

The cabin boasts room for 2 to spend the night and see the sun rise through its wide side windows. Plus, there's an optional full enclosed marine toilet.

VERSATILITY

How do you like your cockpit area? Its adjustable reclining bench offers 3 configurations: up, chaise lounge and extra-large sun lounge. These let you choose from a multitude of activities: talk, dine, relax, read, sunbathe, you name it! The co-pilot seat has a dual function as well. Sit down in the forward-facing seat or use it to expand the seating area and sun lounge. Want even more space? The foredeck transforms into a sun lounge, too.

SMART EDITION

Be sure to get what you need: the Smart Edition is based on the options that are most frequently requested by our customers. In addition to that you save an average of 10% when compared to ordering options separately.



ACTIV 755 CRUISER



Versatile cockpit area: Suitable for 1. Cruising and dining
 2. Relaxing and reading with the inclinable backrest 3. Extra-large sun lounge for a maximum sunbathing capacity and easy water access.
 Storage below seating and dedicated storage for the cockpit table



Optional galley with integral sink, cutting board and LPG stove



Ergonomic helm with SmartCraft instrumentation with mounting space for optional 9" GPS/Chart Plotter and Mercury NMEA 2000 gateway module for engine data



Swim platform extensions

Double co-pilot seat with bi-directional seat backrest and storage underneath the seat



Integrated armrests and blue LED cup holders on both starboard and portside

15, 19 & 20



Large skylight on deck for ample light in cabin. Spacious cabin with double berth and large storage below. Large side windows with opening portlights for natural lighting and ventilation

21



Optional enclosed sea toilet

Permanent and easy access to the cabin and foredeck



14

17



Large foredeck sun lounge for reading and relaxing

MODEL FEATURES

1. Versatile cockpit area: Suitable for 1. Cruising and dining 2. Relaxing and reading with the inclinable backrest 3. Extra-large sun lounge for a maximum sunbathing capacity and easy water access
2. Double co-pilot seat with bi-directional seat backrest and storage underneath the seat
3. Optional galley with integral sink, cutting board and LPG stove
4. Ergonomic helm with SmartCraft instrumentation with mounting space for optional 9" GPS/Chart Plotter and Mercury NMEA 2000 gateway module for engine data
5. Integrated armrests and blue LED cup holders on both starboard and portside
6. Storage below seating and dedicated storage for the cockpit table
7. Convenient storage area for small items in front of the co-pilot seat
8. Deep cockpit for more safety and dryer ride
9. Wide aft cockpit entry
10. Integrated canvas storage
11. Swim platform extensions
12. Single engine configuration up to max 300 hp
13. Comfortable bucket seat with flip bolster & swivel
14. Permanent and easy access to the cabin and foredeck
15. Large skylight on deck for ample light in cabin
16. Anchor storage/windlass
17. Large foredeck sun lounge for reading and relaxing
18. Safe access via the bow
19. Spacious cabin with double berth and large storage below
20. Large side windows with opening portlights for natural lighting and ventilation
21. Optional enclosed sea toilet
22. Wide step for convenient and safe access
23. Bench with storage underneath

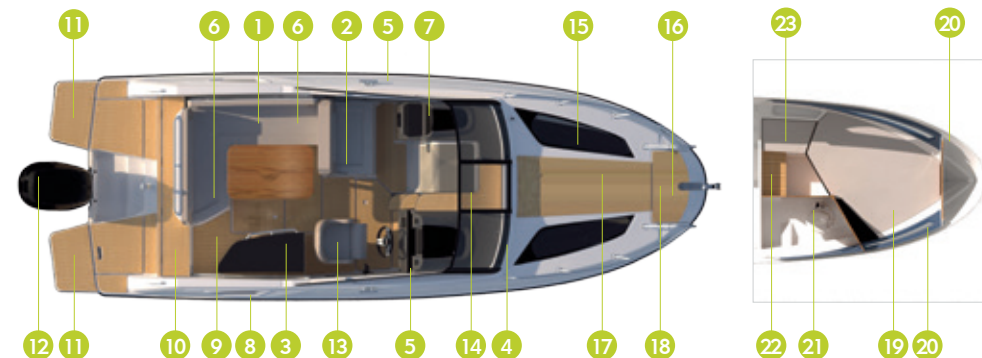

ACTIV 645 CRUISER

SMART THINKING

The ease of access through bow and stern; the well thought-out cockpit; the seamless integration of the features. The Activ 645 Cruiser allows intelligent design and engineering to work as one. From the reassurance of rugged decking to the classic horseshoe seating and bow cabin for sleeping or storage, this is an easy-going experience. Feeling hungry? You're free to quickly convert your cockpit into a relaxed dining area that comfortably seats six people.



Length Overall (M)	6,33
Beam Maximum (M)	2,39
Height - Without Canvas (M)	1,79
Dry Weight (Kg)	1060
Fuel Capacity (L)	160
CE Design Category	C
Maximum Number of People	7
Maximum Power (HP / KW)	200 / 147

SAFETY

The beautiful contemporary styling of the Activ 645 Cruiser has not been at the expense of safety. Excellent safety features include easy access in and out of the cockpit along with anti-slip stairs to the water and an anti-slip flat canopy storage surface. There's also an extra high freeboard for added safety and access to the bow is via large steps.

COMFORT

Good looking and a great experience too. In the cockpit, there are swivel driver and passenger seats and a teak dining table that seats six and effortlessly doubles up as sun lounge. Below deck, the cabin comes with the option of a flush toilet, lateral ventilation and lighting and a seating area that converts easily in to a large double berth.

VERSATILITY

Entertaining, sunbathing or water sports, the Activ 645 Cruiser allows you the flexibility to enjoy life on the water on your terms. Conveniently stored under the floor hatch, the central cockpit table can be quickly pulled up for dining or a sunpad added to it, to create a generous sundeck area.

STORAGE

As befitting such a practical boat, storage is very smart with an integrated solution for canvas storage. There's also clever table and coolbox storage in the cockpit for easy conversion to sun lounge. Useful additional storage is available under the seats and fender lockers.

SMART EDITION

Be sure to get what you need: the Smart Edition is based on the options that are most frequently requested by our customers. In addition to that you save an average of 10 % when compared to ordering options separately and this edition is probably already available at your local dealer right now.



ACTIV 645 CRUISER

4



U-Shaped seating convertible to dining area and sun lounge

10 & 11



Integrated solution for canvas storage
Easy and safe access in and out of the water

7 & 9



Co-pilot storage / easy cabin access
Safe access via the bow

9



Safe access via the bow

5



Table and electric cool box storage

Integrated swim ladder
Fender storage locker

1 & 2





4

Dining area with a large teak table



8

Cabin with double berth and optional sea toilet



4

Large cockpit sun lounge



8

Cabin with double berth and optional sea toilet

MODEL FEATURES

1. Integrated swim ladder
2. Fender storage locker
3. Storage under seating
4. Dining area with a large teak table that converts into a large sun lounge
5. Table and electric cool box storage
6. Swivel bolster seat (pilot and co-pilot)
7. Co-pilot storage / easy cabin access
8. Cabin with double berth and optional sea toilet
9. Safe access via the bow
10. Integrated solution for canvas storage
11. Easy and safe access in and out of the water
12. Integrated helm with hydraulic steering, SmartCraft instrumentation, mounting area for optional 7" GPS/ Chart Plotter and 12v outlet
13. Forward sun lounge
14. Opening deck hatch

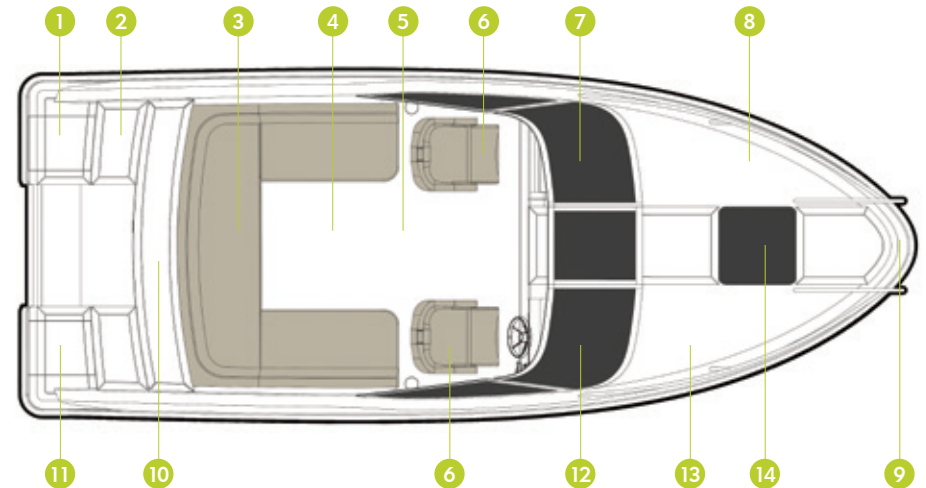

ACTIV 595 CRUISER

COMPACT CRUISING IN COMFORT

This compact day cruiser will appeal to those wanting to enjoy reliability, performance and style. Its intelligent design features maximise the space available, whilst the wealth of thoughtful touches by our experienced designers help make life aboard a pleasure. The Activ 595 Cruiser shares some of the award-winning features of its sister the Activ 645 Cruiser.



Length Overall (M)	5,73
Beam Maximum (M)	2,29
Height - Without Canvas (M)	1,85
Dry Weight (Kg)	890
Fuel Capacity (L)	110
CE Design Category	C
Maximum Number of People	6
Maximum Power (HP / KW)	150 / 110



SAFETY

Safety is never an afterthought with Quicksilver. The Activ 595 Cruiser has the features a discerning boater expects as standard, from its solid build quality down to hydraulic steering and sport steering wheel and engine pre-rigging for speedy, safe and smooth navigation. Good cockpit depth provides a feeling of security on board whilst stepped access to the stern gives safe and easy access to the water.

COMFORT

Rain need never stop your play on the 595: a complete enclosure canvas gives rapid coverage in a downpour, whilst the bimini cover gives sun shade when things start to hot up. To add your own touches of luxury, there is the option of real teak table, complete enclosure canvas, mooring cover, custom seat covers and more.

VERSATILITY

Perfect for active days and relaxing nights, the Activ 595 Cruiser has all you need to do your own thing in style and comfort. Flexible enough to accommodate a range of activities, whether swimming, skiing, sunbathing, fishing or dining, this boat allows everyone to do their own thing in style and comfort.

STORAGE

Every inch counts on this boat and dedicated storage has been anticipated for all on-board items, such as navigation lights and ski mast, the 4 storage compartments over the transom can accommodate sports and fishing gear, and glove box. Integrated canopy storage means that your canvas can be packed away neatly with the minimum of fuss. Finally the 12v cool box option means there will always be something cold waiting for you at the end the longest, hottest days.

SMART EDITION

Be sure to get what you need: the Smart Edition is based on the options that are most frequently requested by our customers. In addition to that you save an average of 10 % when compared to ordering options separately and this edition is probably already available at your local dealer right now.



ACTIV 595 CRUISER

8



Cabin with double berth

4



Dining table

3



Storage under seating

12



Integrated helm with hydraulic steering, SmartCraft instrumentation, mounting area for optional 7" GPS/Chart Plotter and 12v outlet

11



Easy and safe access in and out of the water

Fender storage locker

2

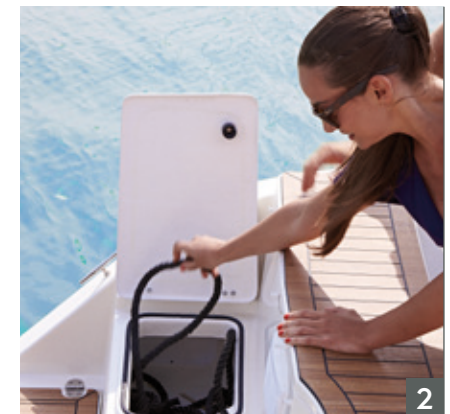



7 & 9

Co-pilot storage / easy cabin access
Safe access via the bow



1 Integrated swim ladder



6

6 Swivel bolster seat (pilot and co-pilot)



5

5 Table and electric cool box storage

MODEL FEATURES

1. Integrated swim ladder
2. Fender storage locker
3. Storage under seating
4. Dining table
5. Table and electric cool box storage
6. Swivel bolster seat (pilot and co-pilot)
7. Co-pilot storage / easy cabin access
8. Cabin with double berth
9. Safe access via the bow
10. Integrated solution for canvas storage
11. Easy and safe access in and out of the water
12. Integrated helm with hydraulic steering, SmartCraft instrumentation, mounting area for optional 7" GPS/ Chart Plotter and 12v outlet
13. Forward sun lounge
14. Opening Deck Hatch

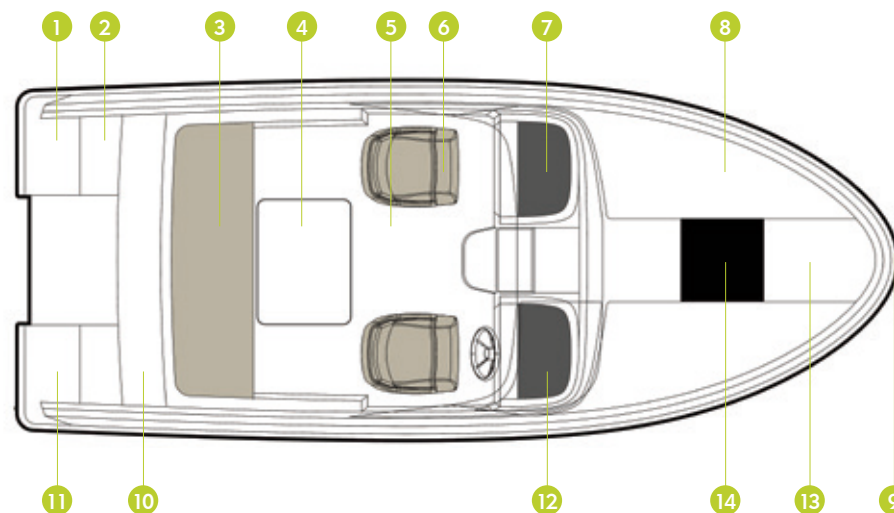

ACTIV 805 SUNDECK

SUN, SEA AND UNMISTAKABLE STYLE

If you're looking for the perfect combination of performance and comfort in the 7-8 meter range, then look no further than Quicksilver's Activ 805 Sundeck. Designed with sun and relaxed cruising and water sports in mind, the Activ 805 Sundeck lives up to its name with a versatile configuration that offers one of the largest sundeck surface in its category. But it's also big on comfort, accommodating up to nine people and comfortable sleeping for up to four adults. Not to mention performance and safety values for which Quicksilver craft are renowned.



Length Overall (M)	7,88
Beam Maximum (M)	2,55
Height - Without Canvas (M)	2,71
Dry Weight (Kg)	1820
Fuel Capacity (L)	280
CE Design Category	C
Maximum Number of People	9
Maximum Power (HP/KW)	400 / 294



SAFETY

The Activ 805 Sundeck offers a wide range of safety features that will allow you to enjoy the water in complete security. Powerful single or twin-engine option delivers great acceleration and top speed, while Mercury technology ensures safe and precise handling. Its solid hull, high freeboards and ergonomic helm make it an extremely safe boat at any speed and in a variety of weather conditions.

COMFORT

With overnight accommodation facilities designed to cater for up to four adults in complete comfort, the Activ 805 Sundeck offers a spacious cabin with a private bathroom with sink and optional marine toilet. For daytime use the Activ 805 Sundeck accommodates up to nine adults in comfort and style, making it perfect for unforgettable high-performance leisure cruising, sun bathing and fun with friends and family.

DESIGN

With its sleek, fluid lines, the Activ 805 Sundeck's stylish proportions create an unmistakable presence on the water. Both above decks and below, the Activ 805 Sundeck offers stylish design elements such as clever extra seating around the cabin L-shape table, and a translucent cabin door and large hullside windows, providing lots of light in the cabin and a spacious and airy feeling.

VERSATILITY

The last word in versatility, the Activ 805 Sundeck offers the largest Sundeck area in its class, with an easily deployable forward sunbathing area featuring twin chaise-lounges and a wide flat area, as well as versatile cockpit area. The cockpit can be transformed from a seating area to a dining area and a large sundeck in just minutes. The cabin is perfect to accommodate up to four people for overnighting but the main berth can also be converted into a seating area with table.

SMART EDITION

Be sure to get what you need: the Smart Edition is based on the options that are most frequently requested by our customers. In addition you save an average of 10% when compared to ordering the options separately. The Smart Edition has short delivery times and is probably already available.



ACTIV 805 SUNDECK



1

Versatile cockpit area convertible to completely extended sun lounge area for maximum sunbathing capacity and easy water access



1 & 4

Versatile cockpit area convertible to dining area
Permanent galley with stainless steel sink, cutting board, standard 12V cooler/optional fridge, LPG stove

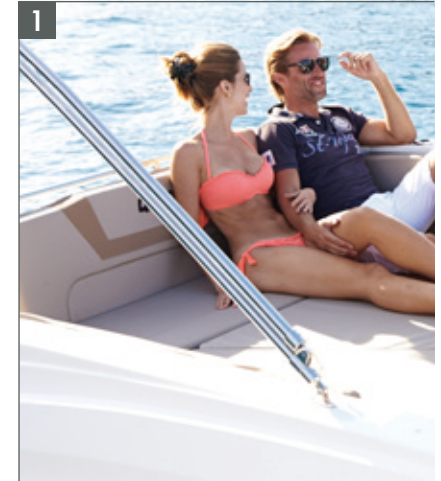

1

Versatile cockpit area convertible to sun lounge area with inclined backrest



13, 14 & 15

Wide aft cockpit entry
Double swim platform
Motor well bridge: easy access to both sides of transom



9

Easy and wide steps to bow sun lounge area

Ergonomic helm with instrumentation, optional 9" Simrad Chart Plotter, vessel view and SmartCraft instrumentation



6

10



Large and versatile forward sun lounge with 3 adjustable backrests for sitting, sun bathing and chaise lounge position

12



Separated head with sink and optional toilet

Cabin: for 4 adults. The main berth is convertible to a seating area with table. Door and large windows in the hull provide ample natural light in the cabin area

Translucent cabin

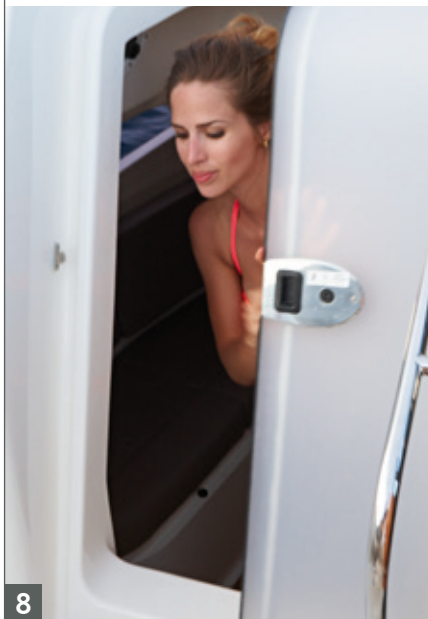

8



12

MODEL FEATURES

1. Versatile cockpit area, convertible for: 1) cruising and dining area 2) sun lounge area with inclined backrest, ideal for reading and relaxing 3) completely extended sun lounge area for maximum sunbathing capacity and easy water access
2. Optional Flip Seat
3. Convenient storage below cockpit floor
4. Permanent galley with stainless steel sink with cutting board lid, standard 12V cooler, optional fridge & LPG stove
5. Easy walking access from bow to stern
6. Ergonomic helm with instrumentation, optional 9" Simrad Chart Plotter, vessel view and SmartCraft instrumentation
7. Comfortable bucket seats or optional leaning post
8. Translucent cabin
9. Easy and wide steps to bow sun lounge area
10. Large and versatile forward sun lounge with 3 adjustable backrest positions for sitting, sun bathing and chaise lounge position
11. Anchor storage/windlass
12. Cabin for 4 adults consisting of main forward berth, mid berth, separated head and sink and optional toilet. The main berth is convertible to a seating area with table. Door and large windows in the hull provide ample natural light in the cabin area
13. Wide aft cockpit entry
14. Double swim platform
15. Motor well bridge: easy access to both sides of transom
16. Single or twin engine configuration capability of max 400 hp

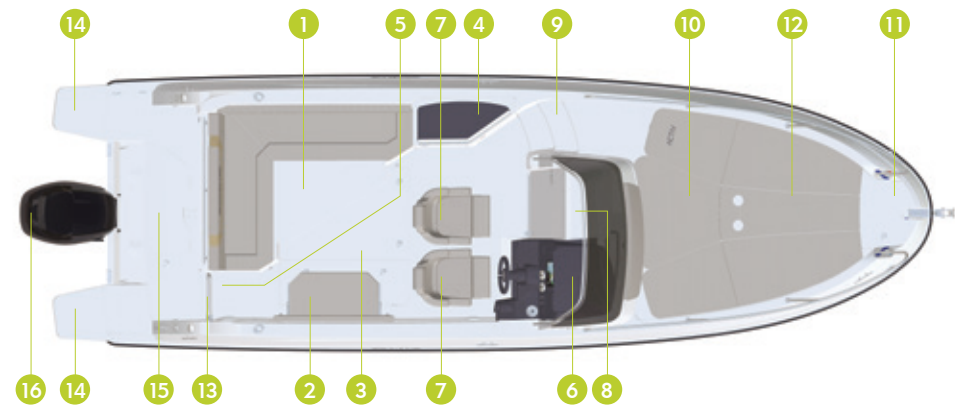

ACTIV 755 SUNDECK

LIVE ON THE SUNNY SIDE OF LIFE

The perfect combination of performance, comfort and versatility in the 7m+ boat segment, Quicksilver's Activ 755 Sundeck is designed with sun, relaxation and enjoyable cruising in mind. With a range of versatile configurations that offer great sun lounging as well as seating accommodation facilities, the Activ 755 Sundeck is designed for fast day cruising and water sports for up to eight people and comfortable overnighting for two.



Length Overall (M)	7,23
Beam Maximum (M)	2,55
Height - Without Canvas (M)	2,21
Dry Weight (Kg)	1468
Fuel Capacity (L)	280
CE Design Category	C
Maximum Number of People	8
Maximum Power (HP/KW)	300 / 221



SAFETY

Unmistakably a high-performance craft, the Activ 755 Sundeck also offers a full range of safety features to allow you, your friends and family to enjoy the water in complete security. On the move, the up to 300 horsepower outboard power unit gives the Activ 755 Sundeck plenty of power, while its excellent handling and ergonomic pilot post make it a joy to use for water sports and fast cruising.

COMFORT

With its extra-large sunbathing foredeck area, with integrated headrests and cup holders, the Activ 755 Sundeck offers optimal sunbathing conditions for up to 3 people. Enjoy a cold drink or a meal thanks to the galley that comes with sink, running water, refrigerator and a single burner stove for maximum comfort. Inside, the cabin offers comfortable daytime and dining use for up to four people, as well as overnighting for two.

DESIGN

Fluid, sleek and stylish are the watchwords when it comes to the new Activ 755 Sundeck's exterior design, while the intelligent design features onboard, make this stylish craft an experience not to be missed. From the helm station's excellent console layout, to the multiple seating configurations both in the cabin and the cockpit, the Activ 755 Sundeck uses intelligent design to offer a maximum of possibilities.

VERSATILITY

The last word in versatility, the Activ 755 Sundeck offers a large forward sunbathing area, a versatile cockpit seating that can transform to a dining area and a cabin configuration that can also be used for dining, sleeping for two, and even as a comfortable play area for children.

SMART EDITION

Be sure to get what you need: the Smart Edition is based on the options that are most frequently requested by our customers. In addition to that you save an average of 10 % when compared to ordering options separately and this edition is probably already available at your local dealer right now.



ACTIV 755 SUNDECK



14

Large permanent bow sundeck area



6

Versatile cockpit area with standard L-lounge seat configuration that can partially be cleared for easy access to transom and extendable to optional U-lounge with port flip-up seat.



13

Side steps provide easy access to bow sundeck area



12

The cabin seating area is convertible to a dining area or 2 berths



7

Dining table in cockpit



Double swim platforms

2 & 3



9

Optional port galley includes stainless steel sink with cutting board lid, fridge & LPG stove



10

Ergonomic helm with instrumentation and optional 7" Simrad GPS/Chart Plotter

Twin bucket seats adjustable in height and flip up bolsters

Integrated swim ladder



1



8

MODEL FEATURES

1. Integrated swim ladder
2. Double swim platforms
3. Motor well bridge: easy access to both sides of transom
4. Port opening transom gate
5. Storage under cockpit seating
6. Versatile cockpit area with standard L-lounge seat configuration that can partially be cleared for easy access to transom and extendable to optional U-lounge with port flip-up seat.
7. Dining table
8. Twin bucket seats adjustable in height and flip up bolsters
9. Optional port galley includes stainless steel sink with cutting board lid, fridge & LPG stove
10. Ergonomic helm with instrumentation and optional 7" Simrad GPS/Chart Plotter
11. Lockable acrylic sliding cabin entry door
12. Cabin with optional concealed sea toilet. The cabin seating area is convertible to a dining area or 2 berths
13. Side steps provide easy access to bow sundeck area
14. Large permanent bow sundeck area
15. Anchor storage/windlass

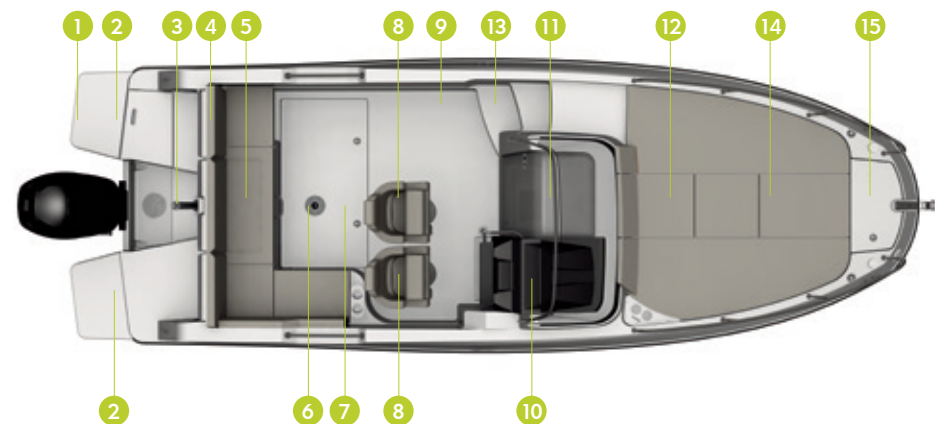

ACTIV 675 SUNDECK

SUN LOVER

The Activ 675 Sundeck's updated, contemporary design wows in any water. And there's much more than meets the eye. Jump aboard to experience for yourself how space, comfort and ergonomics come together. For example, the helm now makes better use of the available surface, is easier to work with and has improved functionalities. Along with you behind the wheel, there's room for up to 7 passengers who want to soak up the sun.



Length Overall (M)	6,74
Beam Maximum (M)	2,55
Height - Without Canvas (M)	2,10
Dry Weight (Kg)	1 123
Fuel Capacity (L)	200
CE Design Category	C
Maximum Number of People	8
Maximum Power (HP / KW)	200 / 147



SAFETY

The Activ 675 Sundeck is powered by an outboard Mercury engine with up to 200 hp. On board, accessibility to the bow and to other parts of the boat is high thanks to the wide steps to the bow, intelligently placed handrails and a high freeboard. A restyled windshield with new tinted glass (30/70 blend) was developed to improve the pilot's view. Water enthusiasts will love the pivoting backrest to reach the swim platform effortlessly.

COMFORT

The 2-meter long sundeck is raising the bar for all sundecks in this boat's category. If you can't stand the heat, stay out of the sun lounge. Which is very well possible. A sliding door leads into the cabin with plenty of seating space. At night, it's converted into a comfortable double berth. In the cockpit, the improved pilot bucket seats swivel any way you like and have been reinforced to offer more comfort.

VERSATILITY

The cockpit is the most versatile area on the Activ 675 Sundeck. A pivoting backrest leads to the swim platform and the ski mast. After a bit of water sports action, a removable table and the pivoting pilot seats turn the cockpit into a fancy dining area for 4. Starboard and portside integrated cup holders included. The cabin configuration is multi-purposeful as well. Enjoy some relaxing time on the U-shaped seating or transform the cabin into a cosy bedroom for 2.

STORAGE

Storage space easy to find on the Activ 675 Sundeck. A non-exhaustive list includes the space underneath the aft seating, ample room in the cabin and a storage tray in the helm console. This means there's dedicated storage for both your permanent equipment (cushions, exterior table, ski mast, navigation light, life jackets) and for other small items and personal belongings.

SMART EDITION

Be sure to get what you need: the Smart Edition is based on the options that are most frequently requested by our customers. In addition to that you save an average of 10 % when compared to ordering options separately.

ACTIV 675 SUNDECK

12



Large bow sun lounge

6



Port and starboard pivoting backrest allowing an easy access to the swim platforms

16

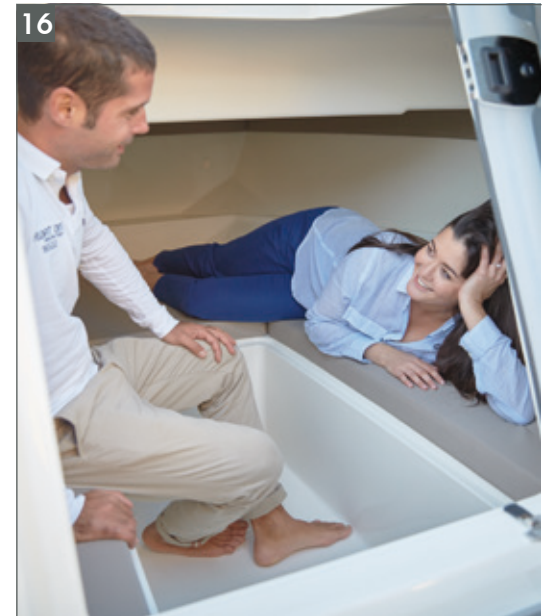

U shape seating in cabin

9



Cockpit table

Twin cup holders. Stylish and ergonomic bicolor helm with room for optional 7" GPS/Chart Plotter

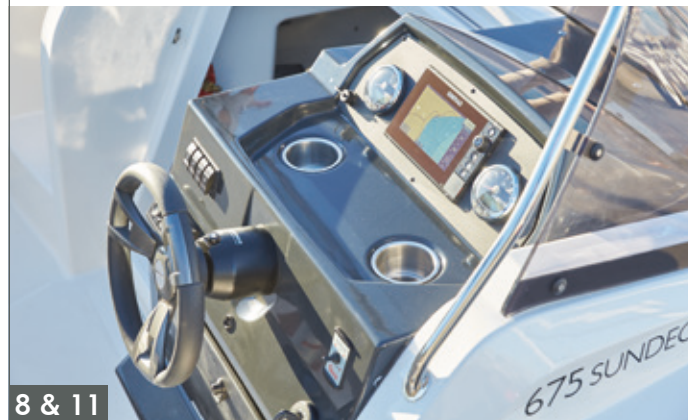

8 & 11

17



Double berth designed for comfortably sleeping two adults



3 Large swim platform for safe and easy access in and out of the water



15 Wide steps to forward sun lounge



1 & 4 Engine configuration up to max 200 hp. Optional cockpit shower



Semi-transparent sliding door

MODEL FEATURES

1. Engine configuration up to max 200 hp
2. Integrated swim ladder
3. Large swim platform for safe and easy access in and out of the water
4. Optional cockpit shower
5. Optional ski pole
6. Port and starboard pivoting backrest allowing an easy access to the swim platforms
7. Storage below aft seat
8. Twin cup holders
9. Cockpit table
10. Pivoting pilot & co-pilot bucket seats with flip bolster and swivel
11. Stylish and ergonomic bicolor helm with room for optional 7" GPS/Chart Plotter
12. Large bow sun lounge
13. Integrated electric bow windlass
14. Semi-transparent sliding door
15. Wide steps to forward sun lounge
16. U shape seating in cabin
17. Double berth designed for comfortably sleeping two adults

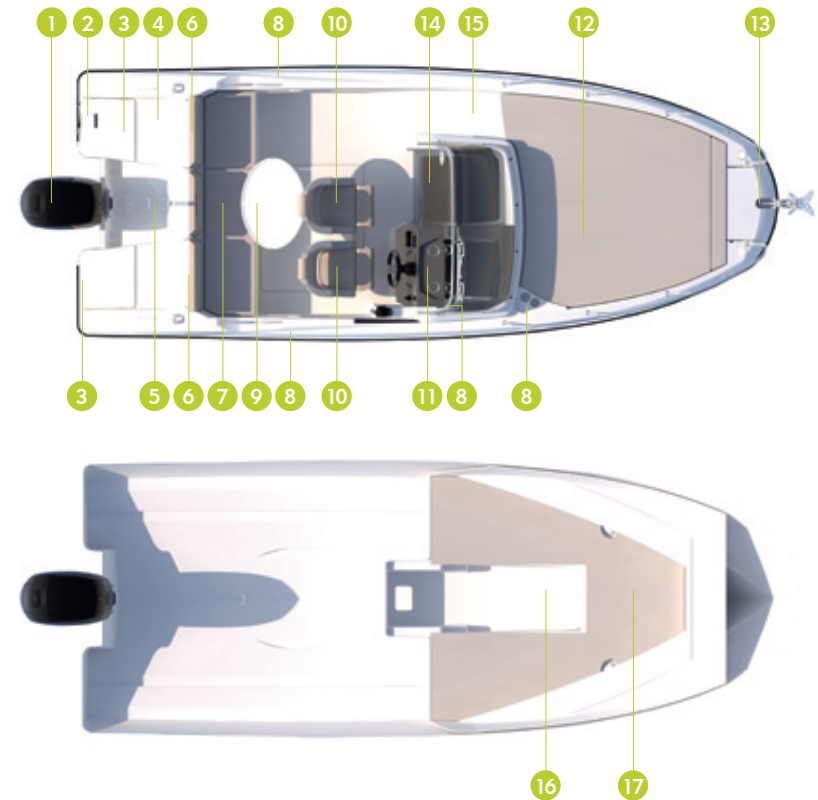

ACTIV 605 SUNDECK

FUN IN THE SUN

The improved Activ 605 Sundeck hits the water with a more dynamic design and upgraded functionalities. It is made for cruising, water sports and fun in the sun. So head out for a day trip with up to 7 people or surprise your partner with a romantic getaway. A Mercury engine with up to 150 hp guarantees safe navigation during the day and the boat's cabin converts into a cosy berth at night.



Length Overall (M)	6,12
Beam Maximum (M)	2,40
Height - Without Canvas (M)	2,02
Dry Weight (Kg)	970
Fuel Capacity (L)	160
CE Design Category	C
Maximum Number of People	7
Maximum Power (HP / KW)	150 / 110



SAFETY

Safety begins with a reliable engine. The Activ 605 Sundeck is compatible with a series of single outboard Mercury engines (115-150 hp). On board, wide steps to the sun lounge area, a high freeboard and well-placed handrails provide passengers with all the support and comfort they need to move around freely. A pivoting backrest allows for an unobstructed access to the swim platform and the integrated swim ladder.

COMFORT

The Activ 605 Sundeck has one of the largest sundecks in its category. Even the bow anchor locker is covered with a cushion to extend the sunbathing area to the max. The helm of the boat has been completely redesigned for a more modern, stylish look and improved use of space for instrumentation. At the same time, the pilot and co-pilot bucket seats with flip bolsters, swivels have been fortified for enhanced driver comfort.

VERSATILITY

Flexibility is a given on the new Activ 605 Sundeck, both on and below the deck. The cockpit converts into a dining area for up to 4 adults, thanks to the removable table, starboard and portside integrated cup holders and pivoting pilot seats. Cabin space can be used as a U-shaped seating area or as a comfortable 2-person sleeping berth, depending on the cushion configuration. An optional ski mast adds water sports to the list of activities the boat has in store.

STORAGE

Storage capacity on the boat is plentiful. For starters, the bow anchor and line locker are fully integrated. The exterior table and filler cushions fit into a dedicated storage area and the same goes for the stern navigation light and water sports equipment. Supplementary storage space for small items and personal belongings is located both underneath the aft seat and below the berth in the cabin.

SMART EDITION

Be sure to get what you need: the Smart Edition is based on the options that are most frequently requested by our customers. In addition to that you save an average of 10% when compared to ordering options separately.



ACTIV 605 SUNDECK

15



Wide steps to forward sun lounge

14



Semi-transparent sliding door

Engine configuration up to max 150 hp.
Easy and unobstructed access to and from the swim platform via a pivoting backrest



1 & 6

Double berth



17

Optional ski pole



5

8 & 11



Twin cup holders. Stylish and ergonomic bicolor helm with room for optional 7" GPS/Chart Plotter



3 Large swim platform for safe and easy access in and out of the water

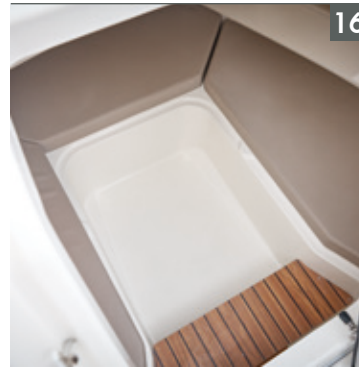

16 U shape seating in cabin

Pivoting pilot & co-pilot bucket seats with flip bolster and swivel



10



12

Large bow sun lounge

MODEL FEATURES

- 1.** Engine configuration up to max 150 hp
- 2.** Integrated swim ladder
- 3.** Large swim platform for safe and easy access in and out of the water
- 4.** Optional cockpit shower
- 5.** Optional ski pole
- 6.** Easy and unobstructed access to and from the swim platform via a pivoting backrest
- 7.** Storage below aft seat
- 8.** Twin cup holders
- 9.** Cockpit table
- 10.** Pivoting pilot & co-pilot bucket seats with flip bolster and swivel
- 11.** Stylish and ergonomic bicolor helm with room for optional 7" GPS/Chart Plotter
- 12.** Large bow sun lounge
- 13.** Integrated electric bow windlass
- 14.** Semi-transparent sliding door
- 15.** Wide steps to forward sun lounge
- 16.** U shape seating in cabin
- 17.** Double berth

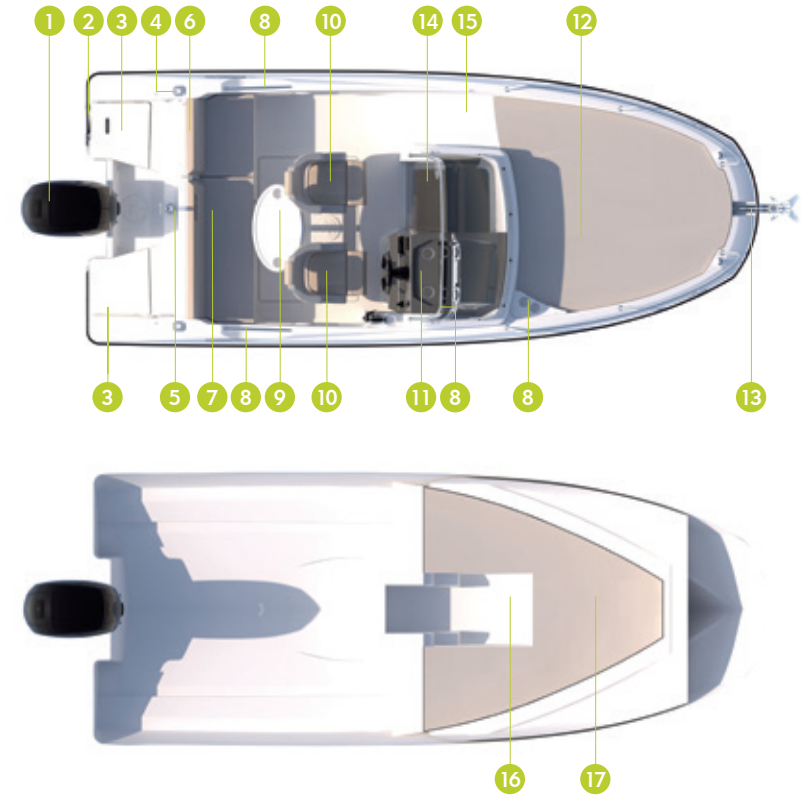

SPECIFICATIONS & PACKS



MERCURY THE POWER TO ESCAPE

Choose among our vast range of robust and powerful Mercury outboard engines, the most appreciated of all time. You'll have the very best and most up-to-the-minute engine power to take your boat out to enjoy the delights of the water.

Moreover, you will benefit from a national and international network of dealers for service. Additionally, a five-year warranty programme is applicable for all eligible Mercury outboard engines*. The programme will be offered to owners of new Mercury outboard engines**. The warranty applies to Mercury Verado®

and FourStroke engines purchased in Europe, the Middle East, Africa and the CIS region.

The five years of comprehensive factory-backed coverage includes labour for failures caused by defects in material or workmanship. What's more, the new warranty is transferable if the engine is sold within the five-year period. The warranty applies to recreational use only.

* Conditions and exclusions apply.

** Provided that all extended warranty conditions are met.

MERCURY ENGINE OPTION	805 CRUISER	755 CRUISER	645 CRUISER	595 CRUISER	805 SUNDECK	755 SUNDECK	675 SUNDECK	605 SUNDECK
Mercury F115 / F115 CT				x				x
Mercury F150		x	x	x		x	x	x
Mercury 175 Verado	x	x	x		x	x	x	
Mercury 200 Verado	x	x	x		x	x	x	
Mercury 225 Verado	x	x			x	x		
Mercury 250 Verado	x	x			x	x		
Mercury 300 Verado	x	x			x	x		
Mercury 350 Verado	x				x			
Mercury 400R Verado	x				x			
2x Mercury F150	x				x			
2x Mercury 175 Verado	x				x			
2x Mercury 200 Verado	x				x			

MODEL SPECIFICATIONS

MODEL SPECIFICATIONS	805 CRUISER	755 CRUISER	645 CRUISER	595 CRUISER	805 SUNDECK	755 SUNDECK	675 SUNDECK	605 SUNDECK
Length Overall (M)	7,88	6,99	6,33	5,73	7,88	7,23	6,74	6,12
Length of Hull (M)	7,63	6,91	6,12	5,65	7,63	6,95	6,45	5,75
Beam Maximum (M)	2,55	2,55	2,39	2,29	2,55	2,55	2,55	2,4
Height - Without Canvas (M)	2,26	2,03	1,79	1,85	2,71	2,21	2,10	2,02
Dry Weight (Kg)	1813	1440	1060	890	1820	1468	1123	970
Draft Hull (M)	0,60	0,55	0,49	0,43	0,56	0,55	0,44	0,44
Fuel Capacity (L)	280	280	160	110	280	280	200	160
CE Design Category	C	C	C	C	C	C	C	C
Maximum Number of People	9	8	7	6	9	8	8	7
Maximum Power (HP)	400	300	200	150	400	300	200	150
Maximum Power (kW)	294	221	147	110	294	221	147	110
Water Capacity (L)	80	80	45	45	80	80	45	45
OB Shaft Length	XL	XL	XL	XL	XL	XL	XL	XL



PACKS AND EDITIONS

PACKS AND EDITIONS	805 CRUISER	755 CRUISER	645 CRUISER	595 CRUISER	805 SUNDECK	755 SUNDECK	675 SUNDECK	605 SUNDECK
SMART EDITION	x	x	x	x	x	x	x	x
Cockpit Comfort Pack	x	x			x			
Cabin Comfort Pack	x	x				x		
Electronic Pack	x	x			x			
Bimini						x	x	x
Bimini with Enclosed Canvas			x	x				
Stereo Fusion with speakers			x	x		x	x	x
Forward sun lounge			x	x				
Port Flip Down Seat						x		
Upgraded fiberglass cockpit table							x	
Real teak cockpit table				x		x		
12v Cool Box			x	x				
Cockpit Shower			x	x			x	x
Ski Pole			x	x				
Bow Electrical Windlass						x	x	
Motorwell Bridge						x		

COCKPIT COMFORT PACK	x	x			x			
Starboard Flip Down Seat					x			
Cockpit Sunlounge	x	x			x			
Refrigerator	x	x			x			
Stove LPG	x				x			
Shower		x						
Ski Pole		x						
Galley (sink w/pressured water & LPG stove)		x						
Port windscreen wiper with washing system		x						
Real teak cockpit table		x						
LED Courtesy Lights		x						

CABIN COMFORT PACK	x	x				x		
Enclosed Sea Toilet	x	x						
Curtains	x	x				x		
Cabin Table						x		
Berth Cushions/Filler						x		

ELECTRONIC PACK	x	x			x			
Simrad GPS/Chart Plotter 9"	x	x			x			
Stereo Fusion with speakers	x	x			x			
Gateway module for engine data	x	x						



SPECIFICATIONS & PACKS

EQUIPMENTS

HULL & DECK	805 CRUISER	755 CRUISER	645 CRUISER	595 CRUISER	805 SUNDECK	755 SUNDECK	675 SUNDECK	605 SUNDECK
Bow Roller	v	v	v	v	v	v	v	v
Swim Ladder	v	v	v	v	v	v	v	v
Navigation Lights	v	v	v	v	v	v	v	v
Forward line/anchor Locker	v	v	v	v	v	v	v	v
Self Bailing Cockpit	v	v	v	v	v	v	v	v
Rod holders					v			
Hull side windows	v	v ¹			v			
Ski Pole	o	o/Cockpit/ED	o/ED	o/ED	o	o	o/ED	o/ED
Swim Platform	v	v	v	v	v	v	v	v
Swim Platform Extension	o	o			o	o		
Real teak Flooring	o	o			o			
Laminated Teak Flooring		o	v	o		o		
Flag holder	v	v	v	v				
Hull Color	o	o	o	o	o	o	o	o
LED Courtesy lights	v	Cockpit/ED			v	v		
Motorwell Bridge	v				v	ED		

HELM	805 CRUISER	755 CRUISER	645 CRUISER	595 CRUISER	805 SUNDECK	755 SUNDECK	675 SUNDECK	605 SUNDECK
SmartCraft Speedometer/Tachometer	v	v	v	v	v	v	v	v
Adjustable Steering Position		v			v	v		
Vessel View					o	o		
Gateway module for engine data	Elec/ED	Elec/ED						
12v electrical socket	v	v	v	v	v	v	v	v
Stereo Fusion with 2 speakers			o/ED	o/ED			o/ED	o/ED
Stereo Fusion with 4 speakers		Elec/ED				o/ED		
Stereo Fusion with 6 speakers	Elec/ED				Elec/ED			
Simrad GPS/Chart Plotter 7" NSS evo 2			o	o		o	o	o
Simrad GPS/Chart Plotter 9" NSS evo 2	Elec/ED	Elec/ED			Elec/ED			

HEAD	805 CRUISER	755 CRUISER	645 CRUISER	595 CRUISER	805 SUNDECK	755 SUNDECK	675 SUNDECK	605 SUNDECK
Sink with pressure fresh water system	v				v			
Enclosed Sea toilet	Cabin/ED	Cabin/ED			o			
Opening Portlight	v	v			v			

COCKPIT	805 CRUISER	755 CRUISER	645 CRUISER	595 CRUISER	805 SUNDECK	755 SUNDECK	675 SUNDECK	605 SUNDECK
Pilot Seat with Flip Bolster and Swivel	v	v	v	v	v	v	v	v
Co-pilot Seat	v	v	v	v	v	v	v	v
Leaning post					o			
Cockpit Sunlounge	Cockpit/ED	Cockpit/ED	v		Cockpit/ED			
Aft Bench Seat	v	v	v	v	v	v	v	v
Aft Seat Folding Backrest	v	v			v			
Aft Seat Extension L-Lounge	v	v	v ²		v	v		
Cockpit Cushions	v	v	v	v	v	v	v	v
Cockpit Table	v			v	v	v	v ³	v
Real teak cockpit table		o/Cockpit/ED	v	o/ED		o/ED		
12v Cool Box	v ⁴		o/ED	o/ED	v ⁴			
Cockpit Shower	v	Cockpit/ED	o/ED	o/ED	v	o	o/ED	o/ED
Starboard Flip Seat					Cockpit/ED			
Port Flip Seat						o/ED		

BOW	805 CRUISER	755 CRUISER	645 CRUISER	595 CRUISER	805 SUNDECK	755 SUNDECK	675 SUNDECK	605 SUNDECK
Forward sun lounge	o	o	o/ED	o/ED	v	v	v	v

CABIN	805 CRUISER	755 CRUISER	645 CRUISER	595 CRUISER	805 SUNDECK	755 SUNDECK	675 SUNDECK	605 SUNDECK
Berths	4	2	2	2	4	2	2	2
Dinette Seat Configuration					v	v		
Berth Cushions/Filler	v	v	v	v	v	Cabin/ED	v	v
Sea Toilet			o			o		
Cabin Lights	v	v	v	v	v	v	v	v
Opening Portlights	v	v			v	v	v	v
Cabin Table					v	Cabin/ED		
Curtains	Cabin/ED				v	Cabin/ED		
Deck Hatch	v		v	v		v		

GALLEY	805 CRUISER	755 CRUISER	645 CRUISER	595 CRUISER	805 SUNDECK	755 SUNDECK	675 SUNDECK	605 SUNDECK
Sink with Tap	v	Cockpit/ED			v	o		
Stove LPG	Cockpit/ED	Cockpit/ED			Cockpit/ED	o		
12v Cool Box	v				v			
Refrigerator	Cockpit/ED	Cockpit/ED			Cockpit/ED	o		

EQUIPMENT	805 CRUISER	755 CRUISER	645 CRUISER	595 CRUISER	805 SUNDECK	755 SUNDECK	675 SUNDECK	605 SUNDECK
Shore Power	o				o			
Grey Water System	o	o			o	o		
Single Battery System			v	v		v	v	v
Dual Battery System	v	v			v			
Bow Thruster	o				o			
Diesel Heating		o						
Bow Electrical Windlass	o	o	o		o	o/ED	o/ED	o
Hydraulic Steering	v	v	v	v	v	v	v	v
Motor Bracket						o	o	o
Electric Trim Tabs	o	o			o	o		
Electric Bilge Pump	v	v	v	v	v	v	v	v
Starboard Windscreen Wiper	v	v	v	v				
Port Windscreen Wiper	v	Cockpit/ED						
Windscreen Wash		Cockpit/ED						
OB Pre-Rigging	v	v	v	v	v	v	v	v

COVER & CANVAS	805 CRUISER	755 CRUISER	645 CRUISER	595 CRUISER	805 SUNDECK	755 SUNDECK	675 SUNDECK	605 SUNDECK
Mooring Cover	o	o	o	o				
Transport Cover						o	o	o
Console & bolster seats cover						o	o	o
Forward Sun Awning						o		
Bimini	o	o	o	o	o	o/ED	o/ED	o/ED
Bimini with Enclosed Canvas	o	o	o/ED	o/ED	o	o		
Seat Cover	A	A	A	A	A	A	A	A
Console Cover						A		

PACKS	805 CRUISER	755 CRUISER	645 CRUISER	595 CRUISER	805 SUNDECK	755 SUNDECK	675 SUNDECK	605 SUNDECK
SMART Edition	o	o	o	o	o	o	o	o
Cabin Comfort Pack	o	o				o		
Cockpit Comfort Pack	o	o			o			
Electronic Pack	o	o			o			

- 1 And integrated skylights on deck
- 2 U-lounge
- 3 Plastic table standard, upgraded fiberglass table part of Smart Edition or stand alone option
- 4 Upgraded to refrigerator in Cockpit Comfort Pack

v = Standard o = Optional A = Accessory ED = Part of Smart Edition
 Cockpit = Part of Cockpit Comfort Pack Cabin = Part of Cabin Comfort Pack
 Elec = Part of Electronic Pack

As a company committed to continuous product improvement specifications are subject to change.



QUICKSILVER®

Explore our dealer network at
www.quicksilver-boats.com



BRUNSWICK MARINE in EMEA
ISO 9001 - 2008 CERTIFIED

The quality system of
Brunswick Marine in EMEA
is ISO 9001:2008 certified.

© 2017 Brunswick Marine in EMEA. All Rights Reserved.

Brunswick Marine in EMEA continuously explores means to improve the products it designs, manufactures and distributes. Every effort is made to produce sales and service literature which is current. Changes to specifications of engines, boats and accessories are ongoing. This brochure should not be regarded as a precise guide to the latest specifications. This brochure is also not an offer for sales of any particular engine, boat or accessory. Distributors and dealers are not agents of Brunswick Marine in EMEA or one of its affiliates and they have no authority to bind Brunswick Marine in EMEA by any express undertaking or representation, including but not limited to representations of product, sales, applications or service nature. Not all products are available in all countries and some are available only in limited quantities. Some products shown in this catalogue are equipped with optional accessories. Please see your local dealer.

www.quicksilver-boats.com

